

TROUBLESHOOTING

Problem	Possible Causes
No picture, no sound	<ul style="list-style-type: none"> • Improper connection with 12v power adapter. • Use of unauthorized power supply • Monitor is in OFF position
No picture	<ul style="list-style-type: none"> • Check whether AV cable is securely plugged in
No sound	<ul style="list-style-type: none"> • Check whether audio connector is secure • Check whether the sound volume is turned off or down
Dark picture	<ul style="list-style-type: none"> • Ensure that bright and contrast settings are properly adjusted • Ensure monitor is warm enough
No color	<ul style="list-style-type: none"> • Ensure color settings are properly adjusted in menu
Upside down or lateral inverted picture	<ul style="list-style-type: none"> • Check horizontal/vertical adjustment on remote
Event Triggers not activating (i.e. No picture during triggered event)	<ul style="list-style-type: none"> • Event trigger is not securely connected
Remote Controller Fault	<ul style="list-style-type: none"> • Battery may be dead or improperly installed: replacement battery Model:CR2025,3V
	<ul style="list-style-type: none"> • Remote controller is not pointed in the direction of the receiving sensor on monitor
	<ul style="list-style-type: none"> • Too far away or improper angle: The maximum effective distance between the remote controller and the receiving sensor is 15 feet and the angle is 30 degrees.
	<ul style="list-style-type: none"> • Obstacle: Move any obstacles out of the path

Dakota Micro, Inc.

8659 148th Ave. SE
Cayuga, ND 58013

www.dakotamicro.com



Quad View Monitoring System

Users Manual

Part Number: DMOV-7MQ-C2



www.dakotamicro.com

FEATURES

- 7 inch LED backlit, high resolution TFT LCD screen is capable of displaying 4 cameras simultaneously
- Wide voltage input: 11-32V
- 4 Channel Inputs, displays 4 images simultaneously
- Manual or automatic image switching modes
- Forward/Mirror image selection
- Event Triggers provided for all 4 cameras. Cameras can be triggered for events such as backing up or applying the brakes
- Power is provided only to the active camera, prolonging the life of the cameras
- AV input and output jacks provided
- Auto ON/OFF LED sensor automatically triggers night vision when required
- Includes credit card style remote control
- Backlit control buttons enable easy menu navigation in all lighting conditions

WARNINGS

- Please read entire manual before using our products
- Before you power your rear OverView system, ensure that all cables are properly connected to avoid damage to the system
- Monitor IS NOT WATERPROOF, please do not place the monitor outdoors
- Ensure that all cables are routed a sufficient distance from high temperature areas and rotary objects
- To ensure proper heat dispersal, ensure that vent holes in monitor remain clear
- Do not open the monitor or camera casing, doing so will void the warranty
- DO NOT watch DVDs etc. while driving
- Please do not use caustic chemicals to wipe the camera and/or monitor



WARNINGS

The OverView camera system is intended for light use and is not intended to be utilized in harsh conditions such as high vibration, high moisture, and use in or around corrosive substances or other high impact or corrosive situations. Should a heavy duty camera be required for your application, an AgCam or EnduraCam camera from Dakota Micro should be utilized and is warranted for this type of use. Warranty will be void on this system should it be utilized outside of its recommended applications.

LIMITED WARRANTY

Subject to the disclaimer, limitations and other directions stated hereafter, Dakota Micro, Inc. warrants that the Product will be free from defects in material and workmanship for periods as stated hereafter from the date of original purchase. **THIS WARRANTY IS EXPRESSLY MADE IN LIEU OF ANY AND ALL OTHER WARRANTIES, EXPRESS OR IMPLIED, INCLUDING THE IMPLIED WARRANTIES OF MERCHANTABILITY OR FITNESS. THE EXCLUSIVE REMEDY OF THE BUYER IS LIMITED TO REPAIR OR REPLACEMENT OF THE PRODUCT. EXCEPT AS STATED IN THIS WARRANTY, DAKOTA MICRO SHALL NOT BE LIABLE FOR ANY LOSS, INCONVENIENCE, OR DAMAGE, INCLUDING DIRECT, SPECIAL, INCIDENTAL, OR CONSEQUENTIAL DAMAGES, RESULTING FROM THE USE OR INABILITY TO USE THE PRODUCT, WHETHER RESULTING FROM BREACH OF WARRANTY, NEGLIGENCE, STRICT LIABILITY OF ANY OTHER LEGAL THEORY.** Any oral statements or representations made by anyone which are contrary to or at variance with the terms stated in this **LIMITED WARRANTY** are void.

Dakota Micro will, at its option, either repair the defect or replace the defective Product or part thereof with a new or remanufactured equivalent at no charge to the purchaser for parts or labor for the period of three (3) years for AgCam/EnduraCam cameras, two (2) years for AgCam/EnduraCam monitors, quads and wireless, Twelve Months (12) for all OverView Cameras & Monitors as well as all other cables and accessories.

The Dakota Micro limited warranty periods outlined above apply throughout the United States and Canada only. A one (1) year maximum limited warranty for all Products applies to all other geographic locations unless otherwise stated in writing by Dakota Micro.

This limited warranty does not apply to any issues connected with appearance that have no relation to the performance of the Product nor to any Product the exterior of which has been damaged or defaced, which has been subjected to improper voltage or other misuse, abnormal service or handling, or which has been altered or modified in design or construction.

In order to enforce the rights under this limited warranty, the purchaser should follow the process set forth on page 3 of this Policy, and provide proof of purchase to Dakota Micro.

Neither the sales personnel of Dakota Micro nor any dealer or any other person is authorized to make any warranties other than those described herein, or to extend the duration of any warranties beyond the time periods described herein.

The warranties described herein shall be the sole and exclusive warranties and remedies provided by Dakota Micro. Correction of defects, in the manner and for the period of time described herein, shall constitute complete fulfillment of all liabilities and responsibilities of Dakota Micro to the purchaser with respect to the Product, and shall constitute full satisfaction of all claims. In no event shall Dakota Micro be liable or in any way responsible for any damages or defects in the Product which were caused by repairs or attempted repairs performed by anyone other than Dakota Micro.

Some states do not allow the limitation on or exclusion of incidental or consequential damages, so said limitation may not apply to you.

Any action at law, suit in equity, or other judicial proceeding for the enforcement of any right provided for herein or otherwise, or with respect to any claim that a purchaser may have against Dakota Micro shall be instituted only in the Courts of the State of North Dakota, either in the state district court located in Wahpeton, North Dakota or in Federal District Court location in Fargo, North Dakota. Without regard to conflicts of law principles, the laws of the state of North Dakota shall govern the interpretation and enforcement of the terms of this Limited Warranty and all aspects of the relationship between Dakota Micro and the purchaser.

This warranty gives you specific legal rights and you may also have other rights, which may vary from state to state.

Included Components

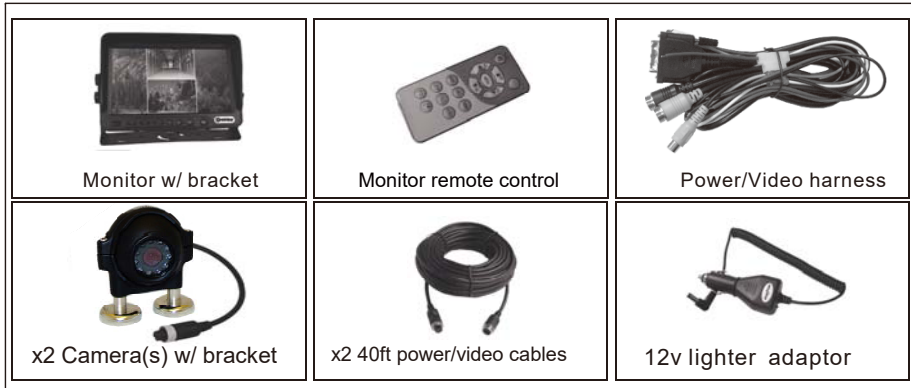

Connection Chart

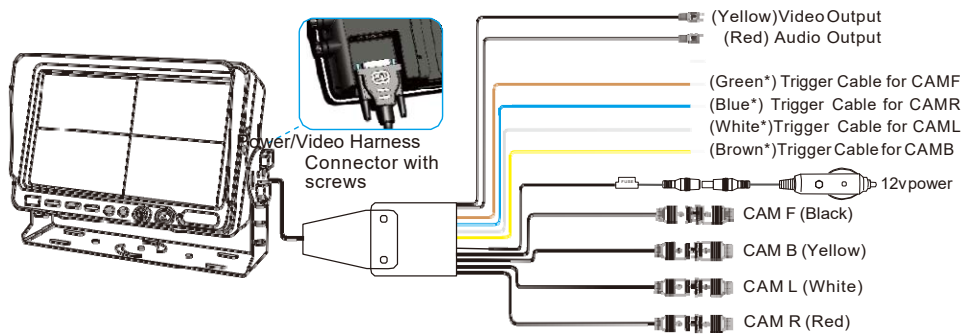

- 1) Cameras 1-4 have an available event trigger wire. Cameras are identified as F (Front), B (Back), L (Left) and R (Right)
- 2) Regardless if monitor is ON or OFF, if power is applied to the trigger, activated camera will become powered
- 3) Camera F has highest priority, camera R the lowest. Example: if both camera F and B are triggered simultaneously, camera F will take precedence.
- 4) Peripheral DVR trigger cable
 1. When the monitor is in quad view or front and back view, the cable has a DC12V output.
 2. When the back trigger cable makes the monitor activated, the peripheral DVR trigger cable has a DC12V output

* Event Trigger wire colors are subject to change without notice and may vary slightly from the colors indicated above.

Monitor

I. Monitor Introduction

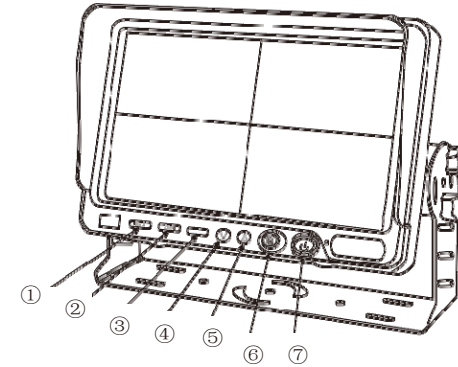

- ① Left/Vol - ② Right/Vol + ③ Menu ④ Down/Cam Selection
⑤ Up/Cam Selection ⑥ Quad View Mode Switch ⑦ ON/OFF

II. Specifications

Screen Size	7" (16:9) digital panel
Overall Size	185mm(W)x124mm(H)x48(D) without mounting bracket
Weight	400g
Power Input	AC 10.5-16.9V, 1,200 ma (2 cameras)
Color System	NTSC/PAL auto switch
Operating Temp	-4°F~122°F (-20°C~50°C)
Brightness	400cd/m ²
Resolution	800(RGB) x 480
Contrast	500:1
Number of Camera Inputs	4

Remote Control

III. Button Function

MUTE

Press Mute to turn sound off, to resume volume, press Mute again or press VOL+.

POWER

Powers monitor ON and OFF.

UP/CAM

- To select menu option.
- To switch images in the mode of one camera view in order: B→L→R→F

VOL-/+

- Adjust volume of monitor.
- Adjust brightness, contrast, etc.
- To activate other functions, such as, mirror/normal image switch, delay time adjustment, etc.

MENU

Displays Monitor Main Menu.

MODE

User can use this key to select four modes: standard color, soft color, rich color and bright.

CALL

Press this button is to display currently displayed AV channel.

TIMR

Time setup of sleep off, it is used to set the time off within 120 minutes.

C/E/P

Language selection: Choice of Chinese or English.

QUAD VIEW SWITCH

Turn monitor on; press Quad view mode switch key, the quad view will be changed in the order displayed below:

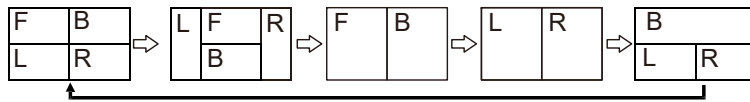

Press this button to flip the picture horizontally.

Press this button to flip the picture vertically.

Monitor

a. Picture:

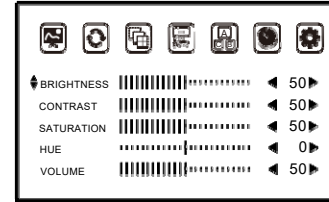

The default value of brightness, contrast and saturation is 50, hue is 0.

The brightness, contrast and saturation value is between 0-100, the hue value is between -5 ~ 5.

b. Channel reverse setting:

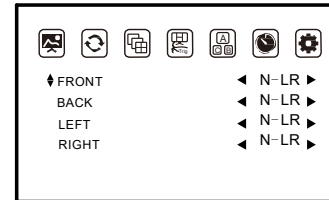

Set each channel image normal or mirror.
↑↓ Arrow Icons allows the image to be inverted.



c. Channel Switch:

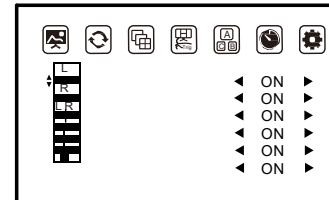

There are 9 image display modes:
Single image (F, B, L, R)
Dual image (F/B, L/R)
Triplex image (B/L/R)
Quad image (田/H)

The six modes in the menu can be set on/off as required
Single image (B,F) and Dual image (F/B) modes are always on.

d. Trigger setting:

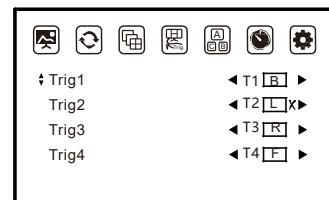

Each trigger wire can trigger any one of the 9 display modes.
Event Trigger function isn't available if there is X near the narrow.

Monitor

III. Installation of Power/Video Harness



IV. Install/Remove Sun Shade

Installation

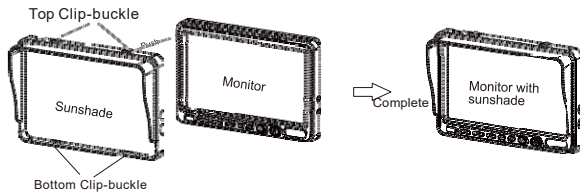

Remove

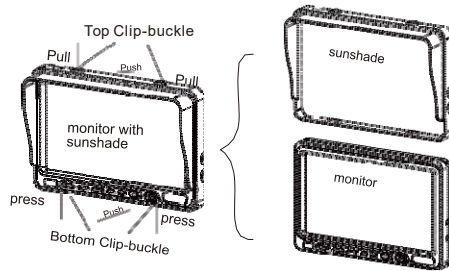

V. Monitor Bracket Installation

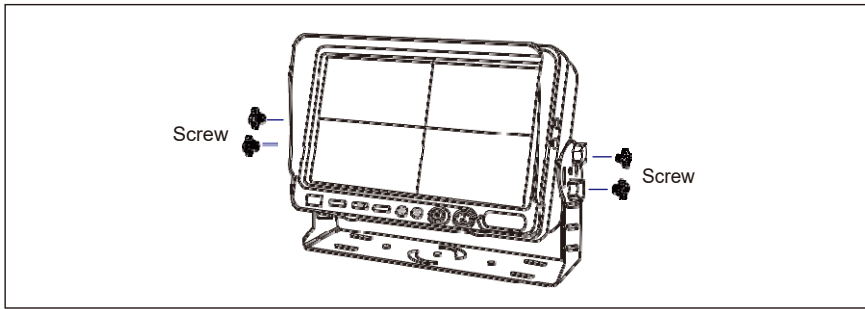

Camera

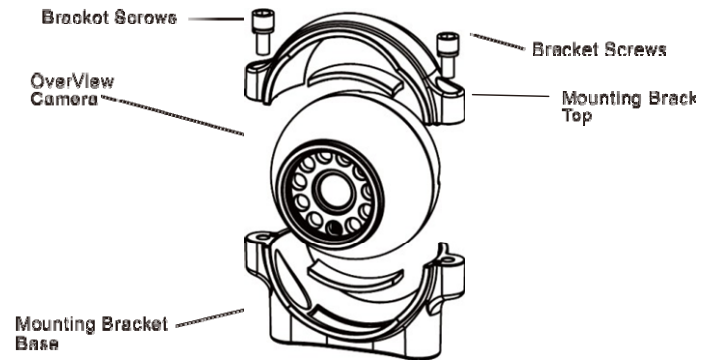

Camera Specifications

Video System	NTSC
Image Pick-up Device	Sharp 1/3" Color CCD
Horizontal Resolution	600 Horizontal lines
Minimum Illumination	0 LUX @ F2.0
Lenses Furnished	Board Lens 2.8mm
Synchronous System	Internal Synchronization
Operating Temp	-4°F ~ 122°F (-20°C ~ 50°C)
Power Supply	DC12v +/-10%
Waterproofing Criteria	IP68K
Dimensions	74mm(W) x 55.5mm(D) x 63.5mm(H)

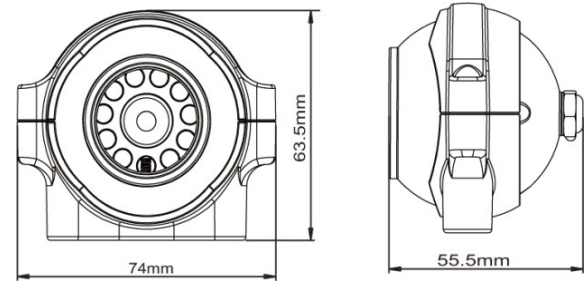

Monitor

e. Reverse priority setting:

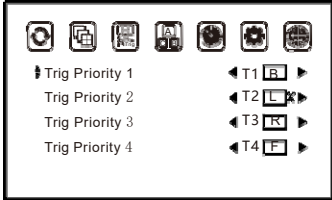

The priority of the 4 triggers can be changed as request. Priority1>Priority2>Priority3>Priority4
Reverse priority setting up isn't available if there is X near the narrow.

f. T-DELAY setting:

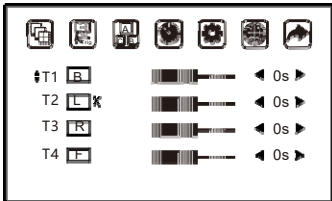

Default delay time for each CH is 0S, you can set the delay time after trigger's stopping.

Delay time can be set to (in seconds): 0S,5S,10S,15S,20S, 25S,30S

Note: If the display mode is turned off, this setting is not functional. During the trigger delay time, the keys do not function.

g. System Setting:

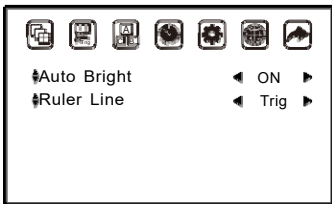

Auto Bright:

ON: The display can automatically adjust the brightness according to external environment

OFF: Auto bright function is OFF

Ruler Ref Line:

ON: The line always shows in the single CH image (B/L/R/F)

Trig: Only shows when the single CH (B/L/R/F) is triggered

OFF: No reference line

The reference line works only when there is a video signal Input into the monitor,s or if the monitor is in multi image display mode.

h. Language



The default language is English, Four languages are optional: English, Chinese, French, Deutsch.

Exit menu and save the settings

Remote Control

I. Introduction

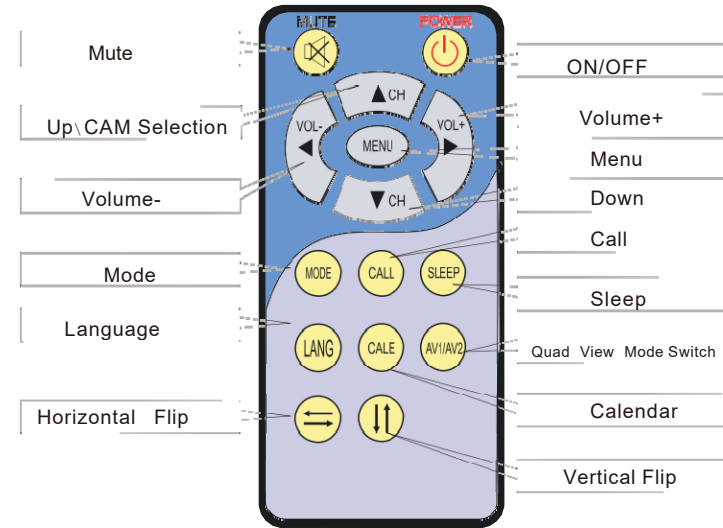

II. Replacing the Battery in your remote

